

SPCTOOLING
ESCOMATIC SPECIALIST

CATALOGO

STRUMENTI

2025

SPC Tooling Sàrl
Route de Boudry 22A
Box 68
CH-2016 Cortaillod
Tel. +41 32 841 44 00

www.spc-tooling.ch

info@spc-tooling.ch

In caso di ordine, per evitare errori di fabbricazione, vogliate precisare:

- Il número di articolo esatto

Dischi di avanzamento:

- In bronzo (filettati)
- In acciaio (standard)
- In guisa (su richiesta)
- Sabbiati (su richiesta)

Bussole di guida D2:

- Possibilità di ottenere delle bussole regolabile.

Pinze e contro pinze:

- Il diametro di serraggio.
- La lunghezza di serraggio per contro pinze non standard.
- Il diametro di passaggio e la lunghezza di serraggio per le grande aperture.
- Contro pinze a naso e contro pinze speciale (fornire disegno o disegno del particolare).
- Possibilità di fabbricare la maggior parte delle contro pinze in metallo duro.

Raddrizza filo:

- Possibilità di ottenere delle bussole grezze in plastica. (da forare voi stesso secondo il diametro).

Utensili D2 - D6 - NM:

- Progettazione e fabbricazione (fornire disegno dell'utensile o disegno del particolare).
- Diversi trattamenti disponibili secondo materiale da lavorare.

Camme:

- Calcolazione di camme per macchine D2- D4 - D5 - D6 (fornire disegno del particolare).
- Fabbricazione di camme in guisa o acciaio con e senza tempra.
- Consegna di attrezzature complete comprese di punte, frese, filiere, godroni, etc...

Revisioni:

- Mandrini D2 - D2H - D2-CNC - D6 - NM - RT - HW.
- Revolver D4 - D5 - D6.
- Quill - Avanzamento - Porta utensili.

Pezzi di ricambio:

- Su richiesta.

Dischi di avanzamento

da \varnothing 0.20 a \varnothing 5.00 in "V"	D2-P-1574-1	
da \varnothing 0.20 a \varnothing 5.00 ronds	D2-P-1574-4	
Filettati	D2-P-1574-6	
Utilizzo: D2 - D2 FLEX SPEED - D4 - D5		

Bussole di guida D2

de \varnothing 0.20 à \varnothing 0.50	D2-P-M24	
de \varnothing 0.51 à \varnothing 1.00	D2-P-M25	
de \varnothing 1.01 à \varnothing 5.00	D2-P-M26	
Utilisation: D2 - D2 FLEX SPEED - D4 - D5		

Lg. 110.00

Bussole di guida D2-CNC

da \varnothing 0.20 a \varnothing 0.50	D2-P-M24-1	
da \varnothing 0.51 a \varnothing 1.00	D2-P-M25-1	
da \varnothing 1.01 a \varnothing 3.50	D2-P-M26-4	
da \varnothing 3.51 a \varnothing 5.00	D2-P-M26-3	
Utilizzo: D2-CNC - D5-CNC		

Lg. 116.00

Contro pinze D2 standard

da \varnothing 0.50 a \varnothing 1.00	D2-P-1588	
da \varnothing 0.50 a \varnothing 1.00 in MD	D2-P-1588-1	
da \varnothing 1.01 a \varnothing 2.50	D2-P-1589	
da \varnothing 1.01 a \varnothing 2.50 in MD	D2-P-1589-1	
Si monta con:		
• Porta pinza	D2-O-M151	
• Boccia conica	D2-O-1629-1	
da \varnothing 2.51 a \varnothing 4.00	D2-P-1590	
da \varnothing 2.51 a \varnothing 4.00 in MD	D2-P-1590-1	
Si monta con:		
• Porta pinza	D2-O-M151	
• Boccia conica	D2-O-1629-2	
da \varnothing 4.01 a \varnothing 5.00	D2-P-1896	
Si monta con:		
• Porta pinza	D2-O-M153	
• Boccia conica	D2-O-1629-2	
Utilizzo: D2 - D2 FLEX SPEED - D2-CNC		

Contro pinze D2 con tubo interno

da \varnothing 0.20 a \varnothing 0.50	D2-P-1591-2
da \varnothing 0.51 a \varnothing 1.50	D2-P-1591-1
da \varnothing 0.30 a \varnothing 1.00 in MD	D2-P-1591-4
da \varnothing 1.01 a \varnothing 1.50 in MD	D2-P-1591-3
Si monta con:	
• Porta pinza	D2-O-M151
• Boccia conica	D2-O-1629-1

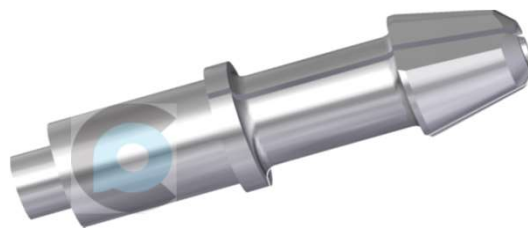

Utilizzo: D2 - D2 FLEX SPEED - D2-CNC

Contro pinze D2 a grande apertura

da \varnothing 0.30 a \varnothing 2.80	D2-P-1892-93
• Apertura 0.70 massimo	
Si monta con:	
• Porta pinza	D2-O-M154
• Boccia conica	D2-X-1891

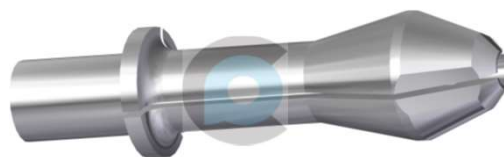

Lg. 28.00

da \varnothing 0.30 a \varnothing 4.00	D2-P-1892-1/93
• Apertura 1.50 massimo	
Si monta con:	
• Porta pinza	D2-O-1567
• Boccia conica	D2-X-1891

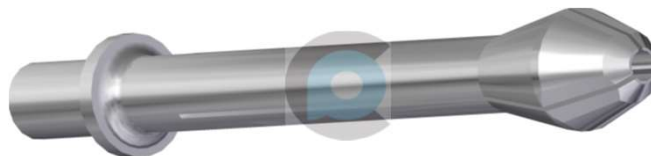

Lg. 48.00

Utilizzo: D2 - D2 FLEX SPEED - D2-CNC

Bussola pinza D2 (senza serraggio)

da \varnothing 0.50 a \varnothing 2.50	D2-P-1596
Si monta con:	
• Porta pinza	D2-O-M151
• Boccia conica	D2-O-1629-1
da \varnothing 2.51 a \varnothing 5.00	D2-P-1597
Si monta con:	
• Porta pinza	D2-O-M151
• Boccia conica	D2-O-1629-2



Utilizzo: D2 - D2 FLEX SPEED - D2-CNC

Contro pinze D4 per estrattore

da \varnothing 0.25 a \varnothing 5.00	D4-P-2046-1
Si monta con:	
• Estrattore fisso	D4-P-2104
o	
• Estrattore mobile	D4-P-2109
• Molla	D4-O-2108
• Tappo	D4-O-2111

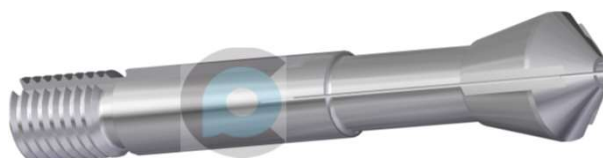

Utilizzo: D2-PM - D4 - D5

Contro pinze D4 per passaggio a traverso

da \varnothing 0.25 a \varnothing 3.00 D4-P-2046-2

Si monta con:

- Tubo interno D4-P-2467
- Tubo di guida D4-P-2113

da \varnothing 3.01 a \varnothing 5.00 D4-P-2046-2

- Senza tubo interno
- Tubo di guida D4-P-2113

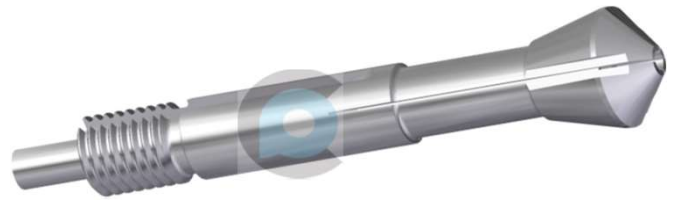

Utilizzo: D2-PM - D4 - D5

Contro pinze D4 a grande apertura per estrattore

da \varnothing 0.30 a \varnothing 4.00 D4-P-2565

Si monta con:

- Porta pinza D4-X-M206
- Estrattore fisso D4-P-2104
- o
- Estrattore mobile D4-P-2109
- Molla D4-O-2108
- Tappo D4-O-2111



Utilizzo: D2-PM - D4 - D5

Contro pinze D4 a grande apertura per passaggio a traverso

da \varnothing 0.30 a \varnothing 4.00 D4-P-2565-69

Si monta con:

- Porta pinza D4-X-M206
- Tubo interno D4-P-2569
- Tubo di guida D4-P-2113
- Da \varnothing 3.00 senza tubo

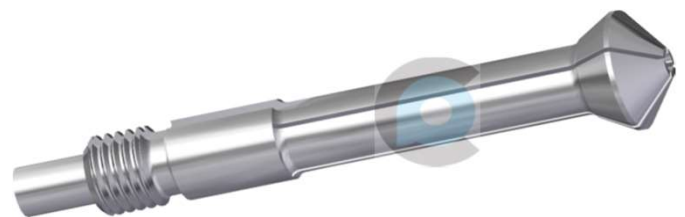

Utilizzo: D2-PM - D4 - D5

Pinze per punte D4

da \varnothing 0.50 a \varnothing 5.00 D4-P-2206

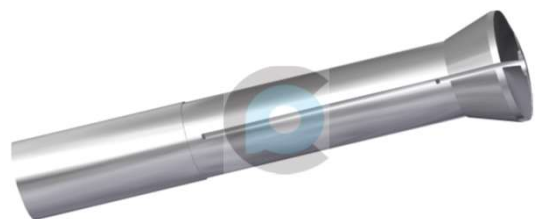

Utilizzo: D4 - D5

Bussole di sicurezza

da \varnothing 0.30 a \varnothing 5.00 DAD-M2



Utilizzo: D2 - D4 - D5

Pinze fisse e pinze di avanzamento D6

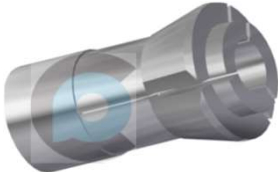
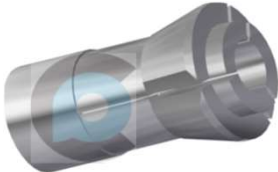
da \varnothing 0.30 a \varnothing 7.00	D6-12-663	
da \varnothing 2.00 a \varnothing 7.00 striato	D6-12-663-STR	
Utilizzo: D6S - D6SR		
da \varnothing 6.35 a \varnothing 9.00	D6-12-4239	
• Pinza fissa		
da \varnothing 6.35 a \varnothing 9.00	D6-12-4195	
• Pinza di avanzamento		
Utilizzo: D6S 9mm - D6SR 9mm		

Bussole di guida D6

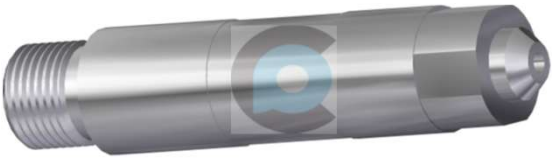
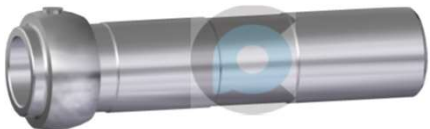
da \varnothing 0.30 a \varnothing 3.99	D6-12-M3	
da \varnothing 4.00 a \varnothing 5.49	D6-12-M4	
da \varnothing 5.50 a \varnothing 6.50	D6-12-M5	
da \varnothing 6.51 a \varnothing 7.10	D6-12-M6	
Utilizzo: D6S - D6SR		
da \varnothing 6.35 a \varnothing 9.00	D6-12-M496	
Utilizzo: D6S 9mm - D6SR 9mm		

Contro pinze D6 per estrattore

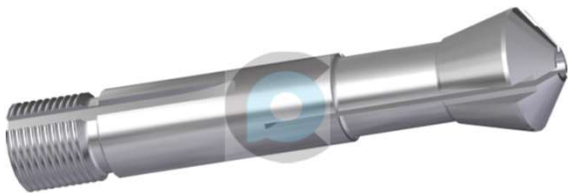
da \varnothing 0.30 a \varnothing 6.35	D6-12-1354	
da \varnothing 6.35 a \varnothing 9.00	D6-12-1354-2	
Si monta con:		
• Estrattore fisso	D6-12-M143	
o		
• Estrattore mobile	D6-12-1356	
• Molla	D6-12-1357	
• Tappo	D6-12-1355	
Utilizzo: D6SR - D6SR 9mm		

Contro pinze D6 per passaggio a traverso

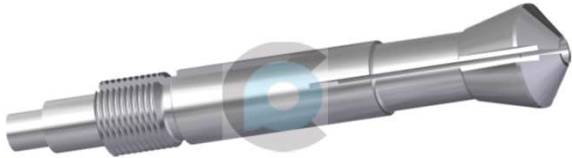
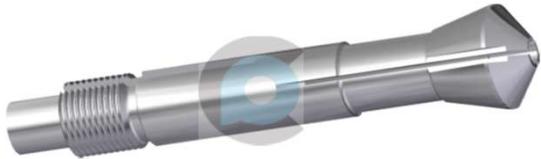
da \varnothing 0.30 a \varnothing 3.00	D6-12-475	
Si monta con:		
• Tubo interno	D6-12-1735	
• Tubo di guida	D6-12-1624	
da \varnothing 3.01 a \varnothing 6.35	D6-12-475-1	
Si monta con:		
• Senza tubo interno		
• Tubo di guida	D6-12-1624	

da \varnothing 3.00 a \varnothing 9.00	D6-12-475-3	
• Corpo \varnothing 14.00		
da \varnothing 3.00 a \varnothing 9.00	D6-12-475-4	
• Corpo \varnothing 12.00		
Utilizzo: D6S - D6SR - D6 9mm		

Contro pinze D6 a grande apertura per estrattore

da \varnothing 0.30 a \varnothing 5.00	D6-12-1700	
Si monta con:		
• Estrattore fisso	D6-12-M143	
o		
• Estrattore mobile	D6-12-1356	
• Molla	D6-12-1357	
• Tappo	D6-12-1355	
Utilizzo: D6SR		

Contro pinze D6 a grande apertura per passaggio a traverso

da \varnothing 0.30 a \varnothing 5.00	D6-12-1700	
Si monta con:		
• Tubo interno	D6-12-1735	
• Tubo di guida	D6-12-1624	
• Da \varnothing 3.00 senza tubo interno		
Utilizzo: D6S - D6SR		

Pinze per punte D6

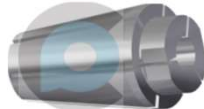
da \varnothing 0.50 a \varnothing 7.00	D6-12-1681	
Utilizzo: D6SR - NM		

Pinze di avanzamento New Mach

da \varnothing 1.50 a \varnothing 6.35	64-A1	
Utilizzo: NM		

Pinze regolabile per controllo materiale New Mach

da \varnothing 0.50 a \varnothing 1.00	64-A3	
da \varnothing 1.00 a \varnothing 1.50		
da \varnothing 1.50 a \varnothing 2.00		
da \varnothing 2.00 a \varnothing 2.50		
da \varnothing 2.50 a \varnothing 3.00		
da \varnothing 3.00 a \varnothing 3.50		
da \varnothing 3.50 a \varnothing 4.00		
da \varnothing 4.00 a \varnothing 4.50		
da \varnothing 4.50 a \varnothing 5.00		
da \varnothing 5.00 a \varnothing 5.50		
da \varnothing 5.50 a \varnothing 6.00		
Utilizzo: NM		

Bussole di guida **New Mach**

da \varnothing 0.50 a \varnothing 3.00 321-0172

da \varnothing 3.01 a \varnothing 6.50 321-0173

- Da \varnothing 4.60 senza tubo

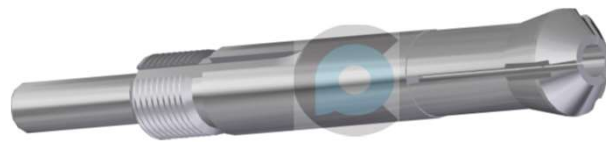

Utilizzo: **NM**

Contro pinze **New Mach** per passaggio a traverso

da \varnothing 0.30 a \varnothing 3.00 121-1481

Si monta con:

- Tubo interno

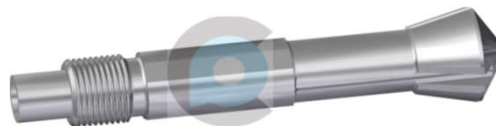

da \varnothing 3.01 a \varnothing 6.35 121-1481

Si monta con:

- Senza tubo interno

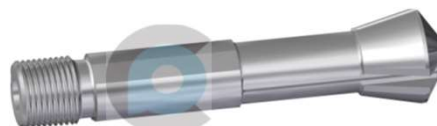

Utilizzo: **NM - D2-CNC - D5-CNC**

Contro pinze **New Mach** per estrattore

da \varnothing 0.30 a \varnothing 6.35 121-1485

Si monta con:

- Estrattore mobile 306-0276
- Molle 63A-554
- Tappo 306-0277

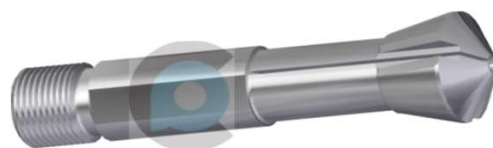

Utilizzo: **NM - D2-CNC - D5-CNC**

Contro pinze **New Mach** a naso per estrattore

da \varnothing 0.30 a \varnothing 4.00 121-1482 o 121-1485-1

Si monta con:

- Estrattore mobile 306-0276
- Molle 63A-554
- Tappo 306-0277

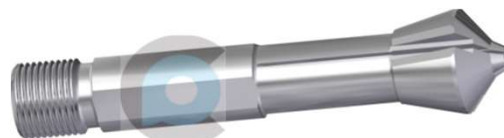

Utilizzo: **NM - D2-CNC - D5-CNC**

Contro pinze **New Mach** a grande apertura per estrattore

da \varnothing 0.30 a \varnothing 5.00 121-1483

Si monta con:

- Estrattore mobile 306-0276
- Molle 63A-554
- Tappo 306-0277

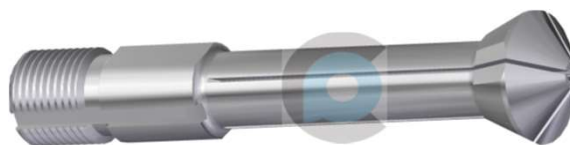

Utilizzo: **NM - D2-CNC - D5-CNC**

Contro pinze **New Mach** a grande apertura per passaggio a traverso

da \varnothing 0.30 a \varnothing 5.00 121-1483

Si monta con:

- Tubo interno
- Da \varnothing 3.00 senza tubo interno

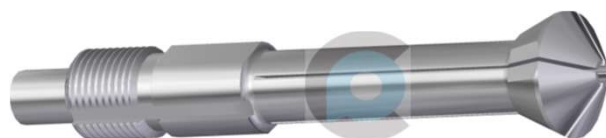

Utilizzo: **NM - D2-CNC - D5-CNC**

Contro pinze **New Mach** a grande apertura con doppio cono

da \varnothing 0.30 a \varnothing 5.00 321-1344

- Apertura 1.50 massimo

da \varnothing 0.30 a \varnothing 5.00 321-1344-2

- Apertura 1.00 massimo

Si monta con:

- Tubo interno
- Estrattore mobile 306-0276
- Molle 63A-554
- Tappo 306-0277

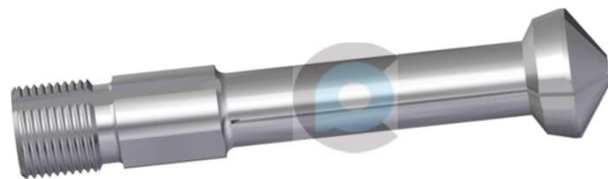

Utilizzo: NM - D2-CNC - D5-CNC

Contro pinze **New Mach** a naso e grande apertura con doppio cono

da \varnothing 0.30 a \varnothing 5.00 321-1344-1

- Apertura 1.50 massimo

da \varnothing 0.30 a \varnothing 5.00 321-1344-3

- Apertura 1.00 massimo

Si monta con:

- Tubo interno
- Estrattore mobile 306-0276
- Molle 63A-554
- Tappo 306-0277

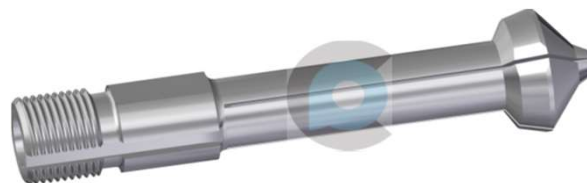

Utilizzo: NM - D2-CNC - D5-CNC

Porta bussole e bussole rotative di raddrizzamento

Porta bussole D6-14-M280-A1-3

- Si vende solo per set completi



da \varnothing 0.20 a \varnothing 0.50 D6-14-2468-1

da \varnothing 0.51 a \varnothing 1.00 D6-14-2468-2

da \varnothing 1.01 a \varnothing 2.00 D6-14-2468-3

Profilate D6-14-2468

- Le bussole si vendono anche all'unità

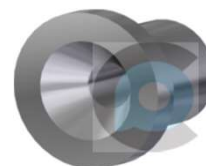

\varnothing corpo 7.00

Utilizzo: D2 - D4 - D5

Porta bussole D6-14-M136-A1-3

- Si vende solo per set completi

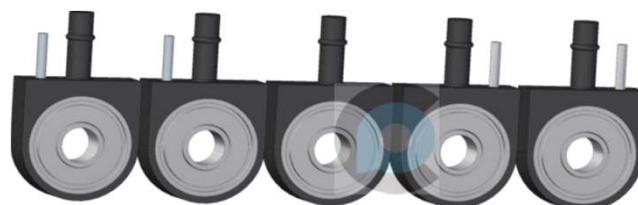

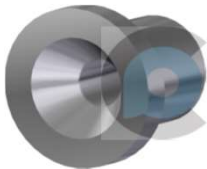
da \varnothing 0.20 a \varnothing 0.50	D6-14-1697-1	 <p>\varnothing corpo 8.00</p>
da \varnothing 0.51 a \varnothing 1.00	D6-14-1697-2	
da \varnothing 1.01 a \varnothing 2.00	D6-14-1697-3	
da \varnothing 2.01 a \varnothing 3.00	D6-14-1697-4	
da \varnothing 3.01 a \varnothing 4.00	D6-14-1697-5	
da \varnothing 4.01 a \varnothing 5.00	D6-14-1697-6	
Profilate	D6-14-1697	
<ul style="list-style-type: none"> Le bussole si vendono anche all'unit� 		

Utilizzo: D2 - D4 - D5 - D6

Porta bussole	D6-14-M104-A1-3	
<ul style="list-style-type: none"> Si vende solo per set completi 		

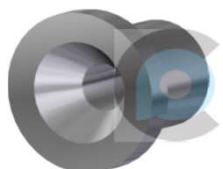
da \varnothing 3.01 a \varnothing 4.00	D6-14-1698-1	 <p>\varnothing corpo 9.00</p>
da \varnothing 4.01 a \varnothing 5.00	D6-14-1698-2	
da \varnothing 6.01 a \varnothing 6.80	D6-14-1698-3	
da \varnothing 6.81 a \varnothing 7.00	D6-14-1698-4	
da \varnothing 5.01 a \varnothing 6.00	D6-14-1698-5	
Profilate	D6-14-1698	
<ul style="list-style-type: none"> Le bussole si vendono anche all'unit� 		

Utilizzo: D6

Porta perni e perni fissi di raddrizzamento

Porta perni	ARD-C-M22-A	
<ul style="list-style-type: none"> Si vendono anche all'unit� 		
da \varnothing 0.20 a \varnothing 0.50	ARD-G-6/1-2	
da \varnothing 0.51 a \varnothing 1.00	ARD-G-7/1-2	
da \varnothing 1.01 a \varnothing 2.00	ARD-G-8/1-2	
da \varnothing 2.01 a \varnothing 3.00	ARD-G-9/1-2	
da \varnothing 3.01 a \varnothing 4.00	ARD-G-10/1-2	
da \varnothing 4.01 a \varnothing 5.00	ARD-G-11/1-2	
da \varnothing 5.01 a \varnothing 6.00	ARD-G-12/1-2	
<ul style="list-style-type: none"> I perni si vendono anche all'unit� 		
Utilizzo: D2 - D4 - D5 - D6		

Bussole rotative di raddrizzamento New Mach

da \varnothing 0.50 a \varnothing 1.00	121-1163
da \varnothing 1.01 a \varnothing 1.50	121-1995
da \varnothing 1.51 a \varnothing 2.00	121-1164
da \varnothing 2.01 a \varnothing 2.50	121-1996
da \varnothing 2.51 a \varnothing 3.00	121-1165
da \varnothing 3.01 a \varnothing 3.50	121-1997
da \varnothing 3.51 a \varnothing 4.00	121-1166
da \varnothing 4.01 a \varnothing 4.50	121-1998
da \varnothing 4.51 a \varnothing 5.00	121-1167
da \varnothing 5.01 a \varnothing 5.50	121-1999
da \varnothing 5.51 a \varnothing 6.00	121-1168
da \varnothing 6.01 a \varnothing 6.50	121-1960

- Le bussole si vendono anche all'unità

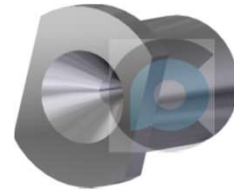

Utilizzo: NM

Bussole di uscita raddrizza filo

\varnothing 0.50	
\varnothing 0.70	
\varnothing 0.90	
\varnothing 1.20	
\varnothing 1.50	
\varnothing 1.80	ARD-G-1
\varnothing 2.20	
\varnothing 2.60	
\varnothing 3.30	
\varnothing 4.30	
\varnothing 5.30	



Utilizzo: D2 - D4 - D5 - D6

Rulli idraulici di raddrizzamento D6

da \varnothing 5.00 a \varnothing 9.00	D6-3-M688-1
Profilati	D6-3-M688-2
• 12 pezzi necessari	
da \varnothing 5.00 a \varnothing 9.00	D6-3-M689-1
Profilati	D6-3-M689-2
• 2 pezzi necessari	
Bussole di sicurezza	D6-12-A290



Utilizzo: D6 9mm

Accessorio di avanzamento AAD

Rapporto 1:1 AAD-M2-1

- Lunghezza massima 50.00 mm

Rapporto 1:1.2 AAD-M2-2

- Lunghezza massima 60.00 mm

Rapporto 1:1.5 AAD-M2-3

- Lunghezza massima 70.00 mm

Unicamente cremagliera e segmento

Cremagliera rapporto 1:1 AAD-10-1

Segmento rapporto 1:1 AAD-63

Cremagliera rapporto 1:1.2 AAD-10-2

Segmento rapporto 1:1.2 AAD-62

Cremagliera rapporto 1:1.5 AAD-10-3

Segmento rapporto 1:1.5 AAD-63-3



Utilizzo: D2 - D4 - D5

Segmento d'accoppiamento

Raddrizzamento 1 x 40° D2-X-M127

Raddrizzamento 1 x 65° D2-X-M126

Raddrizzamento 1 x 130° D2-X-M204

Raddrizzamento 2 x 40° D2-X-M375

Raddrizzamento 2 x 65° D2-X-M141

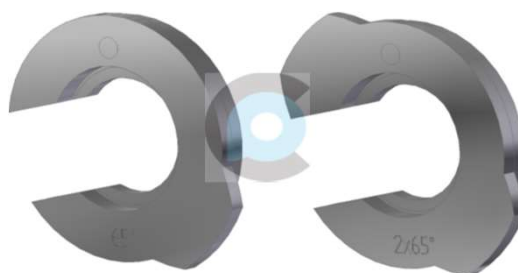

Utilizzo: D2 - D4 - D5

Camma piatta per raddrizza filo ARD

Raddrizzamento 1 x 40° ARD-H-2

Raddrizzamento 1 x 65° ARD-A-83

Raddrizzamento 1 x 130° ARD-H-139

Raddrizzamento 2 x 40° ARD-H-134

Raddrizzamento 2 x 65° ARD-H-10

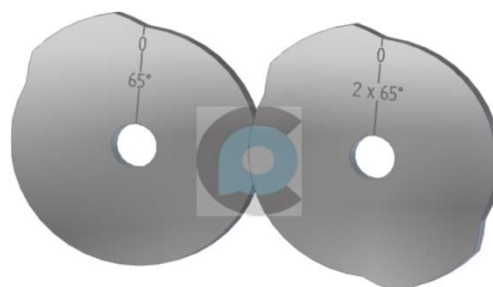

Utilizzo: D2 - D4 - D5

Camma a campana per raddrizza filo ARD

Raddrizzamento 1 x 40° ARD-H-3

Raddrizzamento 1 x 65° ARD-A-11

Raddrizzamento 1 x 130° ARD-H-140



Raddrizzamento 2 x 40° ARD-H-133

Raddrizzamento 2 x 65° ARD-H-9





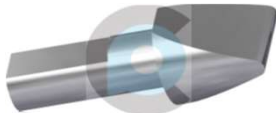
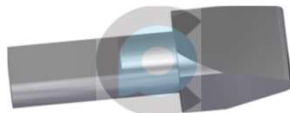
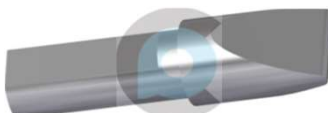
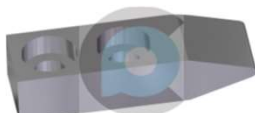

Utilizzo: D2 - D4 - D5

Becchi di camme

Leve utensili e AAD	D2-A-A42	
Acc. di avanzamento AAD	AAD-A2	
Tutte le leve D6	D6-14-A12	
Rotazione revolver	D4-U-2240	
Rotazione revolver	D4-U-2241	
Utilizzo: D2 - D4 - D5 - D6		

Segmenti

Segmento 10°	D4-U-2088-1	
Segmento 15°	D4-U-2088-2	
Segmento 20°	D4-U-2088-3	
<ul style="list-style-type: none"> • Apertura contro pinza D2-PM-D4-D5 • Innesto rotazione revolver D4-D5-D6 		
Segmento 10°	D4-U-2362-1	
Segmento 15°	D4-U-2362-2	
Segmento 20°	D4-U-2362-3	
<ul style="list-style-type: none"> • Chiusura contro pinza D2-PM-D4-D5-D6 • Innesto rotazione revolver D4-D5-D6 		
Segmento 10°	D6-12-1479-1	
Segmento 15°	D6-12-1479-2	
Segmento 20°	D6-12-1479-3	
<ul style="list-style-type: none"> • Apertura contro pinza D6 		
Segmento 20°	D6-12-1447	
Segmento 15°	D6-12-1448	
<ul style="list-style-type: none"> • Raddrizzamento materiale (entrata leva) • Raddrizzamento materiale (ritorno leva) 		
Segmento 15°	D6-12-1480	
Segmento 12°	D6-12-1481	
<ul style="list-style-type: none"> • Innesto filettatura • Rilascio filettatura 		
Utilizzo: D2 - D4 - D5 - D6		

Porta godrone D6

Porta godrone D6-12-M293-1

- Per godrone larghezza 4.00 x ø 15.00

Porta godrone D6-12-M293-2

- Per godrone larghezza 5.00 x ø 15.00



Utilizzo: D6 - D6SR

Porta godrone D2

Porta godrone D2-X-M196-1

- Per godrone larghezza 4.00 x ø 12.00

Porta godrone D2-X-M196-2

- Per godrone larghezza 4.00 x ø 15.00

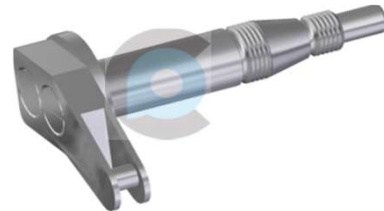

Utilizzo: D2 - D4 - D5

Maschio e porta filiere

Metrico D6-14-M...

- Es. filettatura M3 x0.50 D D6-14-M0.5D

Polici D6-14-Z...

- Es. filettatura 2-64 UNF D6-14-Z64D

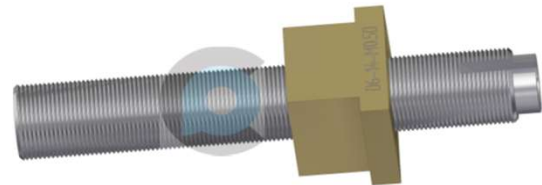

Porta filiera D6-14-1662-1

Porta filiera D6-14-1662-2

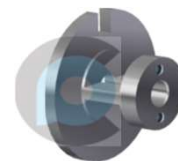

Utilizzo: D6SR

Camma di ritorno D6

0.8°/1mm D6-14-1525

1°/1mm D6-14-1526

1.5°/1mm D6-14-1527-1

2°/1mm D6-14-1527-2

3°/1mm D6-14-1527-3

4°/1mm D6-14-1527-4



Utilizzo: D6 - D6SR