

SPCTOOLING
ESCOMATIC SPECIALIST

CATALOG

TOOLING

2025

SPC Tooling Sàrl
Route de Boudry 22A
Box 68
CH-2016 Cortaillod
Tel. +41 32 841 44 00

www.spc-tooling.ch

info@spc-tooling.ch

In case of order, and to avoid any manufacturing errors, please specify:

- Article number

Feed rollers:

- In bronze (threaded)
- In steel (standard)
- In cast iron (on request)
- Sanded (on request)

Guide bush D2:

- Possibility of having adjustable guide bush.

Collet and counter-collet:

- The clamping diameter
- The clamping length for counter collet if not standard.
- The diameter of passage and the clamping length for large openings.
- Counter-collets with nose and specials counter-collets (provide drawing or drawing of the part).
- Possibility to produce most of hard metal counter collets.

Straightening:

- Possibility of having blank bushes in plastic (to be drilled by yourself according to diameter)

Tools D2 - D6 - NM:

- Design and manufacturing (provide drawing or part drawing to be machined).
- Various surface treatments available according to material to be machined

Cams:

- Cams design for machines D2- D4 - D5 - D6 (provide drawing of the part).
- Cams manufacture in cast iron or steel with ou without hardening.
- Supply of complete tools including drills, holder, mills, knurling tool, ...

Refurbishing:

- Toolheads D2 - D2H - D2-CNC - D6 - NM - RT - HW
- Revolver D4 - D5 - D6
- Quill - Feed block - Tool holder

Spare parts:

- On request

Feed rollers

from \varnothing 0.20 to \varnothing 5.00 "V" D2-P-1574-1

from \varnothing 0.20 to \varnothing 5.00 "U" D2-P-1574-4

Threaded D2-P-1574-6



Use: D2 - D2 FLEX SPEED - D4 - D5

Guide bush D2

from \varnothing 0.20 to \varnothing 0.50 D2-P-M24

from \varnothing 0.51 to \varnothing 1.00 D2-P-M25

from \varnothing 1.01 to \varnothing 5.00 D2-P-M26



Lg. 110.00

Use: D2 - D2 FLEX SPEED - D4 - D5

Guide bush D2-CNC

from \varnothing 0.20 to \varnothing 0.50 D2-P-M24-1

from \varnothing 0.51 to \varnothing 1.00 D2-P-M25-1

from \varnothing 1.01 to \varnothing 3.50 D2-P-M26-4

from \varnothing 3.51 to \varnothing 5.00 D2-P-M26-3



Lg. 116.00

Use: D2-CNC - D5-CNC

Counter collet D2 standard

from \varnothing 0.50 to \varnothing 1.00 D2-P-1588

from \varnothing 0.50 to \varnothing 1.00 HM D2-P-1588-1

from \varnothing 1.01 to \varnothing 2.50 D2-P-1589

from \varnothing 1.01 to \varnothing 2.50 HM D2-P-1589-1

Set up with:

- Collet holder D2-O-M151
- Tapered sleeve D2-O-1629-1

from \varnothing 2.51 to \varnothing 4.00 D2-P-1590

from \varnothing 2.51 to \varnothing 4.00 HM D2-P-1590-1

Set up with:

- Collet holder D2-O-M151
- Tapered sleeve D2-O-1629-2

from \varnothing 4.01 to \varnothing 5.00 D2-P-1896

Set up with:

- Collet holder D2-O-M153
- Tapered sleeve D2-O-1629-2



Use: D2 - D2 FLEX SPEED - D2-CNC

Counter collet D2 with inner tube

from \varnothing 0.20 to \varnothing 0.50	D2-P-1591-2
from \varnothing 0.51 to \varnothing 1.50	D2-P-1591-1
from \varnothing 0.30 to \varnothing 1.00 HM	D2-P-1591-4
from \varnothing 1.01 to \varnothing 1.50 HM	D2-P-1591-3
Set up with:	
• Collet holder	D2-O-M151
• Tapered sleeve	D2-O-1629-1

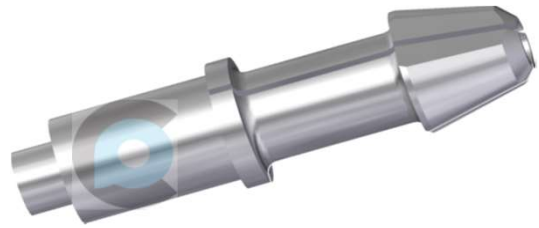

Use: D2 - D2 FLEX SPEED - D2-CNC

Counter collet D2 with large opening

from \varnothing 0.30 to \varnothing 2.80	D2-P-1892-93
• Max. opening 0.70	
Set up with:	
• Collet holder	D2-O-M154
• Tapered sleeve	D2-X-1891

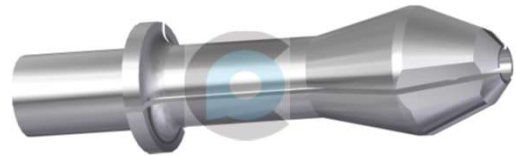

Lg. 28.00

from \varnothing 0.30 to \varnothing 4.00	D2-P-1892-1/93
• Max. opening 1.50	
Set up with:	
• Collet holder	D2-O-1567
• Tapered sleeve	D2-X-1891

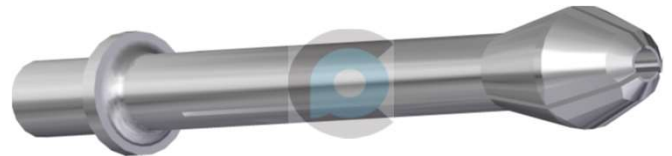

Lg. 48.00

Use: D2 - D2 FLEX SPEED - D2-CNC

Counter bush D2 (without clamping)

from \varnothing 0.50 to \varnothing 2.50	D2-P-1596
Set up with:	
• Collet holder	D2-O-M151
• Tapered sleeve	D2-O-1629-1
from \varnothing 2.51 to \varnothing 5.00	D2-P-1597
Set up with:	
• Collet holder	D2-O-M151
• Tapered sleeve	D2-O-1629-2



Use: D2 - D2 FLEX SPEED - D2-CNC

Counter collet D4 with ejector

from \varnothing 0.25 to \varnothing 5.00	D4-P-2046-1
Set up with:	
• Steady ejector	D4-P-2104
or	
• Mobil ejector	D4-P-2109
• Spring	D4-O-2108
• Stopper	D4-O-2111

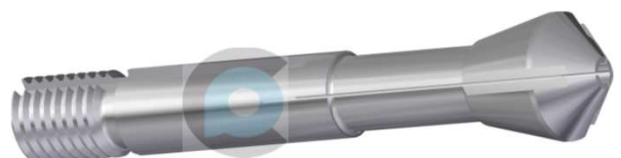

Use: D2-PM - D4 - D5

Counter collet D4 for ejection of part through

from \varnothing 0.25 to \varnothing 3.00 D4-P-2046-2

Set up with:

- Inner tube D4-P-2467
- Guide tube D4-P-2113

from \varnothing 3.01 to \varnothing 5.00 D4-P-2046-2

- Without tube
- Guide tube D4-P-2113

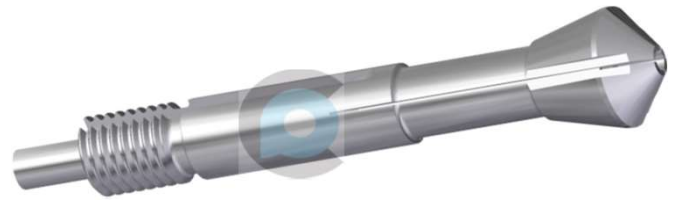

Use: D2-PM - D4 - D5

Counter collet D4 large opening for ejector

from \varnothing 0.30 to \varnothing 4.00 D4-P-2565

Set up with:

- Collet holder D4-X-M206
- Steady ejector D4-P-2104
- or
- Mobil ejector D4-P-2109
- Spring D4-O-2108
- Stopper D4-O-2111



Use: D2-PM - D4 - D5

Counter collet D4 large opening for ejection of part through

from \varnothing 0.30 to \varnothing 4.00 D4-P-2565-69

Set up with:

- Collet holder D4-X-M206
- Inner tube D4-P-2569
- Guide tube D4-P-2113
- From \varnothing 3.00 without tube

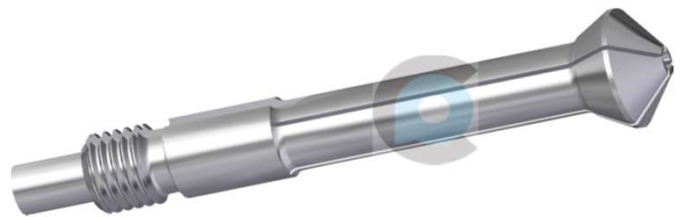

Use: D2-PM - D4 - D5

Collet for drill D4

from \varnothing 0.50 to \varnothing 5.00 D4-P-2206



Use: D4 - D5

Security bush

from \varnothing 0.30 to \varnothing 5.00 DAD-M2



Use: D2 - D4 - D5

Steady and feed collet D6

from \varnothing 0.30 to \varnothing 7.00 D6-12-663

from \varnothing 2.00 to \varnothing 7.00 striped D6-12-663-STR

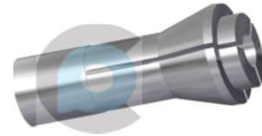

Use: D6S - D6SR

from \varnothing 6.35 to \varnothing 9.00 D6-12-4239

- Steady collet

from \varnothing 6.35 to \varnothing 9.00 D6-12-4195

- Feed collet



Use: D6S 9mm - D6SR 9mm

Guide bush D6

from \varnothing 0.30 to \varnothing 3.99 D6-12-M3

from \varnothing 4.00 to \varnothing 5.49 D6-12-M4

from \varnothing 5.50 to \varnothing 6.50 D6-12-M5

from \varnothing 6.51 to \varnothing 7.10 D6-12-M6



Use: D6S - D6SR

from \varnothing 6.35 to \varnothing 9.00 D6-12-M496

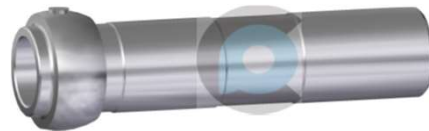

Use: D6S 9mm - D6SR 9mm

Counter collet D6 for ejector

from \varnothing 0.30 to \varnothing 6.35 D6-12-1354

from \varnothing 6.35 to \varnothing 9.00 D6-12-1354-2

Set up with:

- Steady ejector D6-12-M143
or
- Mobil ejector D6-12-1356
- Spring D6-12-1357
- Stopper D6-12-1355

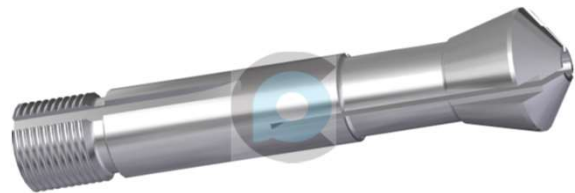

Use: D6SR - D6SR 9mm

Counter collet D6 for ejection of part through

from \varnothing 0.30 to \varnothing 3.00 D6-12-475

Set up with:

- Inner tube D6-12-1735
- Guide tube D6-12-1624

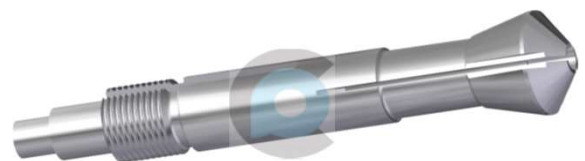

from \varnothing 3.01 to \varnothing 6.35 D6-12-475-1

Set up with:

- Without tube
- Guide tube D6-12-1624

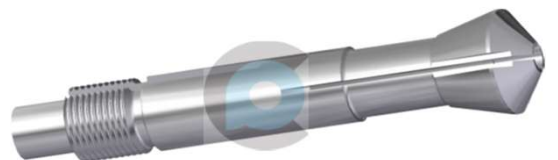

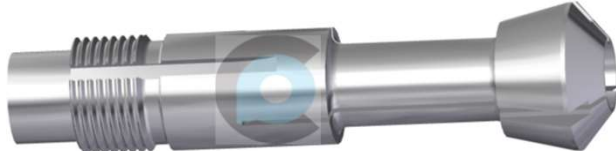
from \varnothing 3.00 to \varnothing 9.00	D6-12-475-3	
• Body \varnothing 14.00		
de \varnothing 3.00 à \varnothing 9.00	D6-12-475-4	
• Body \varnothing 12.00		
Use: D6S - D6SR - D6 9mm		

Counter collet D6 large opening for ejector

from \varnothing 0.30 to \varnothing 5.00	D6-12-1700	
Set up with:		
• Steady ejector	D6-12-M143	
or		
• Mobil ejector	D6-12-1356	
• Spring	D6-12-1357	
• Stopper	D6-12-1355	
Use: D6SR		

Counter collet D6 large opening for ejection of part through

from \varnothing 0.30 to \varnothing 5.00	D6-12-1700	
Set up with:		
• Inner tube	D6-12-1735	
• Guide tube	D6-12-1624	
• from \varnothing 3.00 without tube		
Use: D6S - D6SR		

Collet for drill D6

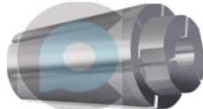
from \varnothing 0.50 to \varnothing 7.00	D6-12-1681	
Use: D6SR - NM		

Feed collet New Mach

from \varnothing 1.50 to \varnothing 6.35	64-A1	
Use: NM		

Material control collet New Mach

from \varnothing 0.50 to \varnothing 1.00	64-A3	
from \varnothing 1.00 to \varnothing 1.50		
from \varnothing 1.50 to \varnothing 2.00		
from \varnothing 2.00 to \varnothing 2.50		
from \varnothing 2.50 to \varnothing 3.00		
from \varnothing 3.00 to \varnothing 3.50		
from \varnothing 3.50 to \varnothing 4.00		
from \varnothing 4.00 to \varnothing 4.50		
from \varnothing 4.50 to \varnothing 5.00		
from \varnothing 5.00 to \varnothing 5.50		
from \varnothing 5.50 to \varnothing 6.00		
Use: NM		

Guide bush **New Mach**

from \varnothing 0.50 to \varnothing 3.00 321-0172

de from 3.01 to \varnothing 6.50 321-0173

- from \varnothing 4.60 without tube

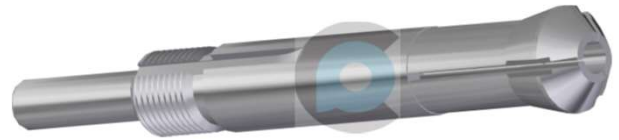

Use: NM

Counter collet **New Mach** for ejection of part through

from \varnothing 0.30 to \varnothing 3.00 121-1481

Set up with:

- Inner tube

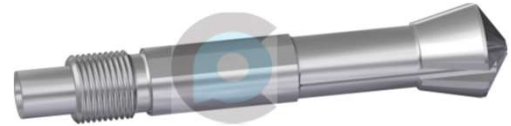

from \varnothing 3.01 to \varnothing 6.35 121-1481

Set up with:

- Without tube

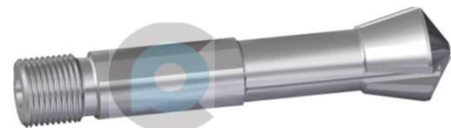

Use: NM - D2-CNC - D5-CNC

Counter collet **New Mach** for ejector

from \varnothing 0.30 to \varnothing 6.35 121-1485

Set up with:

- Mobil ejector 306-0276
- Spring 63A-554
- Stopper 306-0277

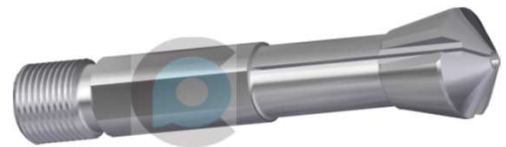

Use: NM - D2-CNC - D5-CNC

Counter collet **New Mach** with nose for ejector

from \varnothing 0.30 to \varnothing 4.00 121-1482 or 121-1485-1

Set up with:

- Mobil ejector 306-0276
- Spring 63A-554
- Stopper 306-0277

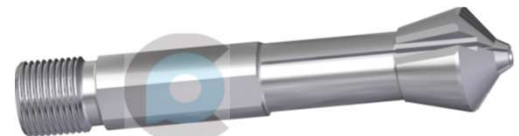

Use: NM - D2-CNC - D5-CNC

Counter collet **New Mach** large opening for ejector

from \varnothing 0.30 to \varnothing 5.00 121-1483

Set up with:

- Mobil ejector 306-0276
- Spring 63A-554
- Stopper 306-0277

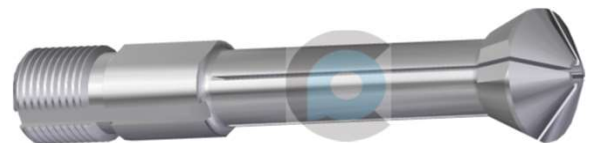

Use: NM - D2-CNC - D5-CNC

Counter collet **New Mach** large opening for ejection of part through

from \varnothing 0.30 to \varnothing 5.00 121-1483

Set up with:

- Inner tube
- From \varnothing 3.00 with tube

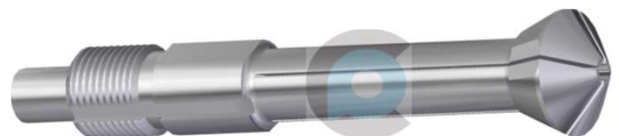

Use: NM - D2-CNC - D5-CNC

Counter collet **New Mach large opening with double taper**

from \varnothing 0.30 to \varnothing 5.00 321-1344

- Max. opening 1.50

from \varnothing 0.30 to \varnothing 5.00 321-1344-2

- Max. opening 1.00

Set up with:

- Inner tube
- Mobil ejector 306-0276
- Spring 63A-554
- Stopper 306-0277

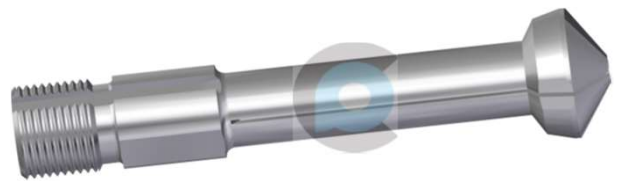

Use: NM - D2-CNC - D5-CNC

Counter collet **New Mach with nose, large opening and double taper**

from \varnothing 0.30 to \varnothing 5.00 321-1344-1

- Max. opening 1.50

from \varnothing 0.30 to \varnothing 5.00 321-1344-3

- Max. opening 1.00

Set up with:

- Inner tube
- Mobil ejector 306-0276
- Spring 63A-554
- Stopper 306-0277

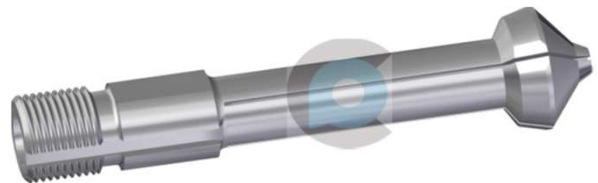

Use: NM - D2-CNC - D5-CNC

Straightening bush holder and **straghtening bushes**

Bush holder D6-14-M280-A1-3

- Sold only by full set



from \varnothing 0.20 to \varnothing 0.50 D6-14-2468-1

from \varnothing 0.51 to \varnothing 1.00 D6-14-2468-2

from \varnothing 1.01 to \varnothing 2.00 D6-14-2468-3

Profiled D6-14-2468

- Bushes are also sold individually

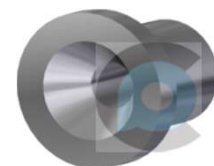

\varnothing body 7.00

Use: D2 - D4 - D5

Bush holder D6-14-M136-A1-3

- Sold only by full set

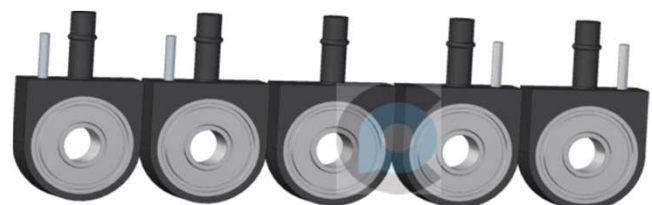

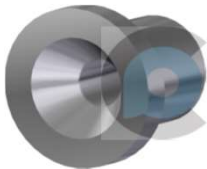
from \varnothing 0.20 to \varnothing 0.50	D6-14-1697-1	 <p>\varnothing body 8.00</p>
from \varnothing 0.51 to \varnothing 1.00	D6-14-1697-2	
from \varnothing 1.01 to \varnothing 2.00	D6-14-1697-3	
from \varnothing 2.01 to \varnothing 3.00	D6-14-1697-4	
from \varnothing 3.01 to \varnothing 4.00	D6-14-1697-5	
from \varnothing 4.01 to \varnothing 5.00	D6-14-1697-6	
Profiled	D6-14-1697	
<ul style="list-style-type: none"> Bushes are also sold individually 		

Use: D2 - D4 - D5 - D6

Bush holder	D6-14-M104-A1-3	
<ul style="list-style-type: none"> Sold only by full set 		

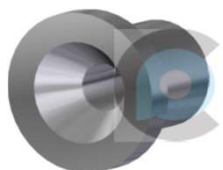
from \varnothing 3.01 to \varnothing 4.00	D6-14-1698-1	 <p>\varnothing body 9.00</p>
from \varnothing 4.01 to \varnothing 5.00	D6-14-1698-2	
from \varnothing 6.01 to \varnothing 6.80	D6-14-1698-3	
from \varnothing 6.81 to \varnothing 7.00	D6-14-1698-4	
from \varnothing 5.01 to \varnothing 6.00	D6-14-1698-5	
Profiled	D6-14-1698	
<ul style="list-style-type: none"> Bushes are also sold individually 		

Use: D6

Straghtening jaw and bushes

Holder	ARD-C-M22-A	
<ul style="list-style-type: none"> Sold individually 		

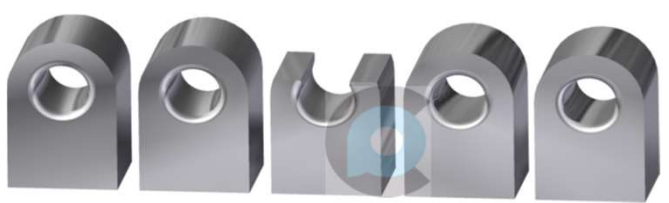
from \varnothing 0.20 to \varnothing 0.50	ARD-G-6/1-2	
from \varnothing 0.51 to \varnothing 1.00	ARD-G-7/1-2	
from \varnothing 1.01 to \varnothing 2.00	ARD-G-8/1-2	
from \varnothing 2.01 to \varnothing 3.00	ARD-G-9/1-2	
from \varnothing 3.01 to \varnothing 4.00	ARD-G-10/1-2	
from \varnothing 4.01 to \varnothing 5.00	ARD-G-11/1-2	
from \varnothing 5.01 to \varnothing 6.00	ARD-G-12/1-2	
<ul style="list-style-type: none"> Bushes are also sold individually 		

Use: D2 - D4 - D5 - D6

Rotating bush NM

from \varnothing 0.50 to \varnothing 1.00	121-1163
from \varnothing 1.01 to \varnothing 1.50	121-1995
from \varnothing 1.51 to \varnothing 2.00	121-1164
from \varnothing 2.01 to \varnothing 2.50	121-1996
from \varnothing 2.51 to \varnothing 3.00	121-1165
from \varnothing 3.01 to \varnothing 3.50	121-1997
from \varnothing 3.51 to \varnothing 4.00	121-1166
from \varnothing 4.01 to \varnothing 4.50	121-1998
from \varnothing 4.51 to \varnothing 5.00	121-1167
from \varnothing 5.01 to \varnothing 5.50	121-1999
from \varnothing 5.51 to \varnothing 6.00	121-1168
from \varnothing 6.01 to \varnothing 6.50	121-1960

- Bushes are also sold individually

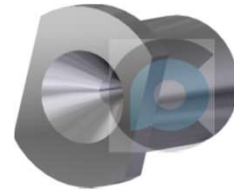

Use: NM

Bush exit straghtening

\varnothing 0.50	
\varnothing 0.70	
\varnothing 0.90	
\varnothing 1.20	
\varnothing 1.50	
\varnothing 1.80	ARD-G-1
\varnothing 2.20	
\varnothing 2.60	
\varnothing 3.30	
\varnothing 4.30	
\varnothing 5.30	

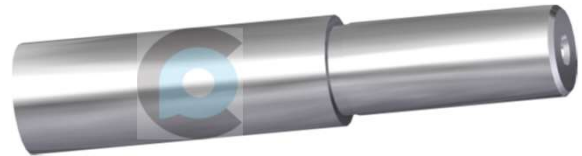

Use: D2 - D4 - D5 - D6

Hydraulic straghtening rollers D6

from \varnothing 5.00 to \varnothing 9.00	D6-3-M688-1
Profiled	D6-3-M688-2
<ul style="list-style-type: none"> • 12 pieces required 	
from \varnothing 5.00 to \varnothing 9.00	D6-3-M689-1
Profiled	D6-3-M689-2
<ul style="list-style-type: none"> • 2 pieces required 	
Security bush	D6-12-A290



Use: D6 9mm

Feed attachment **AAD**

Ratio 1:1 AAD-M2-1

- Max length 50.00 mm

Ratio 1:1.2 AAD-M2-2

- Max length 60.00 mm

Ratio 1:1.5 AAD-M2-3

- Max length 70.00 mm

Only rack and segment

Rack ratio 1:1 AAD-10-1

Segment ratio 1:1 AAD-63

Rack ratio 1:1.2 AAD-10-2

Segment ratio 1:1.2 AAD-62

Rack ratio 1:1.5 AAD-10-3

Segment ratio 1:1.5 AAD-63-3



Use: D2 - D4 - D5

Clutch segment

Straightening 1 x 40° D2-X-M127

Straightening 1 x 65° D2-X-M126

Straightening 1 x 130° D2-X-M204

Straightening 2 x 40° D2-X-M375

Straightening 2 x 65° D2-X-M141

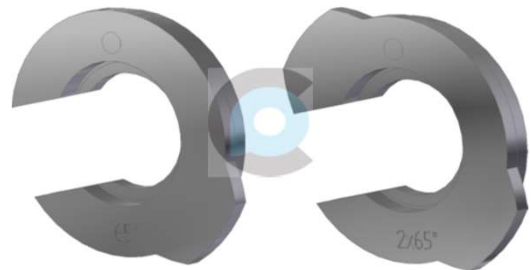

Use: D2 - D4 - D5

Control cam for straightening **ARD**

Straightening 1 x 40° ARD-H-2

Straightening 1 x 65° ARD-A-83

Straightening 1 x 130° ARD-H-139

Straightening 2 x 40° ARD-H-134

Straightening 2 x 65° ARD-H-10

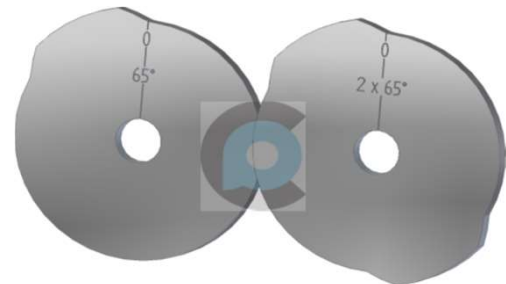

Use: D2 - D4 - D5

Chariot cam for straightening **ARD**

Straightening 1 x 40° ARD-H-3

Straightening 1 x 65° ARD-A-11

Straightening 1 x 130° ARD-H-140



Straightening 2 x 40° ARD-H-133

Straightening 2 x 65° ARD-H-9





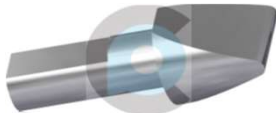
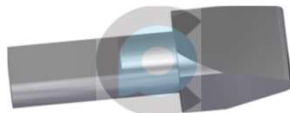
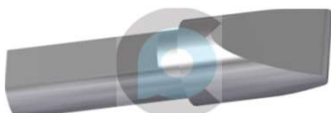
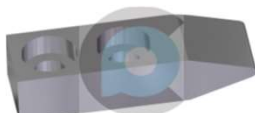

Use: D2 - D4 - D5

Cam followers

Tools lever and AAD	D2-A-A42	
Feed attachment AAD	AAD-A2	
All levers D6	D6-14-A12	
Indexing revolver	D4-U-2240	
Indexing revolver	D4-U-2241	
Use: D2 - D4 - D5 - D6		

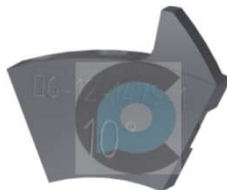
Segment

Segment 10°	D4-U-2088-1	
Segment 15°	D4-U-2088-2	
Segment 20°	D4-U-2088-3	
<ul style="list-style-type: none"> • Opening counter collet D2-PM-D4-D5 • Start of revolver D4-D5-D6 		
Segment 10°	D4-U-2362-1	
Segment 15°	D4-U-2362-2	
Segment 20°	D4-U-2362-3	
<ul style="list-style-type: none"> • Closing counter collet D2-PM-D4-D5-D6 • Start of revolver D4-D5-D6 		
Segment 10°	D6-12-1479-1	
Segment 15°	D6-12-1479-2	
Segment 20°	D6-12-1479-3	
<ul style="list-style-type: none"> • Opening counter collet D6 		
Segment 20°	D6-12-1447	
Segment 15°	D6-12-1448	
<ul style="list-style-type: none"> • Material straightening (entry touch) • Material straightening (return touch) 		
Segment 15°	D6-12-1480	
Segment 12°	D6-12-1481	
<ul style="list-style-type: none"> • Stop of threading • Start of threading 		
Use: D2 - D4 - D5 - D6		

Knurling holder D6

Knurling holder D6-12-M293-1

- For knurling tool width 4.00 x ø 15.00

Knurling holder D6-12-M293-2

- For knurling tool width 5.00 x ø 15.00



Use: D6 - D6SR

Knurling holder D2

Knurling holder D2-X-M196-1

- For knurling tool width 4.00 x ø 12.00

Knurling holder D2-X-M196-2

- For knurling tool width 4.00 x ø 15.00

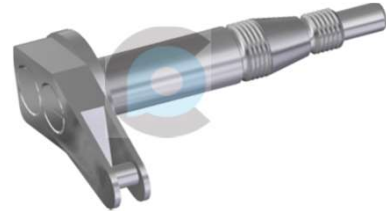

Use: D2 - D4 - D5

Lead screw and die holder

Metric D6-14-M...

- Ex. thread M3 x0.50 D D6-14-M0.5D

Inch D6-14-Z...

- Ex. thread 2-64 UNF D6-14-Z64D

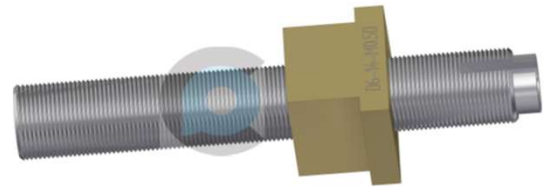

Die holder D6-14-1662-1

Die holder D6-14-1662-2

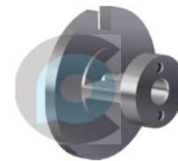

Use: D6SR

Return cam D6

0.8°/1mm D6-14-1525

1°/1mm D6-14-1526

1.5°/1mm D6-14-1527-1

2°/1mm D6-14-1527-2

3°/1mm D6-14-1527-3

4°/1mm D6-14-1527-4



Use: D6 - D6SR